



TECHNICAL SPECIFICATION

MODEL NO.:APMS-100-12 DOCUMENT NO.:_____

CUSTOMER NO.:_____ DATA.:_____

CHANGZHOU AMCFLEX TECHNOLOGY CO LTD
ADD: NO8, HUASHAN ROAD, XINBEI AREA, CHANGZHOU, JIANGSU, CHINA
TEL: 0086 519 69682537 FAX: 0086 519 68693467
Email: info@amcflex.com www.amcflex.com

APMS-100-12

100W Single output with PFC function

IP67 Waterproof LED Power Supply



- Constant Voltage +Constant current Hybrid Mode
- Built-in Active PFC Function, High efficiency up to 92%
- Protection: Overload/Short Circuit/Overheat/Short circuit
- Aluminum housing design with functional Ground
- IP67 full sealed for indoor and outdoor installations
- Super Compact Design
- 5 Years warranty



TECHNICAL PARAMETERS

1. Output

Items	Specs	Unit	Conditions
Rated Output voltage	12	VDC	
Rated Output Current	8.0	A	
Rated Output Power	96	W	
Tcase	90	C°	Ta:50C°, 230VAC, full load
Efficiency	≥92	%	240VAC input, Rated Load
Line Regulation	±0.5%		
Load Regulation	±2.0%		
Voltage tolerance	±3%		
Ripple & Noise(Max)	<150mVp-p		
Rise time	≤60	mS	25C° , full load
Power On Delay time	≤2	S	100-240VAC, full load
Switch off Hold Up time	/	ms	Rated input voltage, rated load

2. Input

Items	Specs	Unit	Conditions
Rated Input voltage	100-240	VAC	
Input voltage range	90-264	VAC	
Input Frequency	47-63(Typical 50/60)	Hz	
Input Current Max	1.5	A	Vin=90Vac, Full Load
Inrush Current	≤50	A	220Vac, full load, 25C°
Power Factor	≥0.95		90~264Vac input, full load
THD	≤15	%	Vin=90~264Vac, full load
NO Load power consumption	<0.5	W	

3. Protection

Current Limiting	110%-160%	A	Hi-CCUP Mode, Auto-recovery after fault condition is removed
Short circuit	Yes		Hi-CCUP Mode, Auto-recovery after fault condition is removed
Over heat	Yes	C°	Shut down output voltage, Auto-recovery after fault condition is removed
Over Voltage	14-18	V	Hi-CCUP Mode, Auto-recovery after fault condition is removed

4. Temperature and others

Operating Temperature range	-40 to +70 (Typical25)	C°	Refer to Derating Curve
Storage Temperature range	-45 to +80 (Typical25)	C°	
Humidity	10 ~ 95	%	NON-Condensing
Altitude	0 ~ 5000	M	Altitude Over 2000 meters, 1.5% derating for every 100 meters increase
Waterproof Level	IP67		
Cooling method	Air convection		
Temperature Coefficient	0.03%/C° (0-60C°)		
Vibration	10-500Hz, 5G 12min./1cycle, period for 72 min, each along X.Y. Z axes		

5. Safety & EMC Standards

Safety standard	UL8750, IEC/EN61347-1,EN61347-2-13,EN62368, GB19510.1,GB19510.14, IP67 Approved	
Withstand voltage	I/P-O/P	3750Vac 10mA (Max)
	I/P-FG	1500Vac 10mA (Max)
	O/P-FG	500Vac 10mA (Max)
Isolation Resistance	I/P-O/P, I/P-FG, O/P-FG:100M Ohms / 500VDC / 25C°/ 70% RH	
Leakage Current	< 0.75mA	240Vac/60Hz

EMC EMISSION

Conducted	EN55015(CISPR15), GB17743
Radiated	EN55015(CISPR15), GB17743
Harmonic Current	EN61000-3-2 , Class C @load \geq 50%
Voltage Flicker	EN61000-3-3

EMC IMMUNITY

ESD	EN61000-4-2, 8KV air ; Level 2, 4KV contact
Radiated	EN61000-4-3
EFT/Burst	EN61000-4-4
Surge	EN61000-4-5, 4KV/Line-Line 6KV/Line-Earth
Conducted	EN61000-4-6
EN61547, Electromagnetic Immunity Requirements applies to lighting Equipment	

Others

MTBF	200Khours, MIL-HDBK-217F (25C°)
Dimension	155(L)*55 (W)*35(H)
Packing	0.5Kg;32pcs/ 17Kg/0.026CBM

6. BLOCK DIAGRAM

PFC fosc : 50~120KHz
 PWM fosc : 60~130KHz

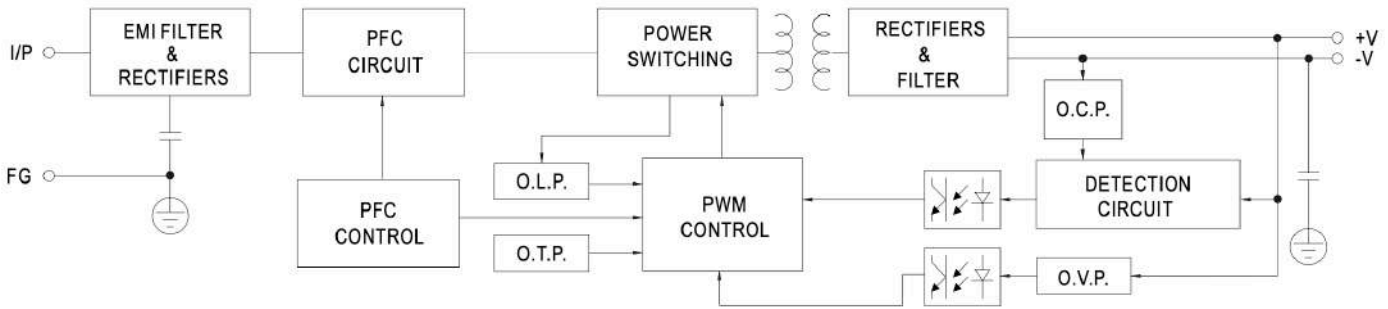

7. DRIVING METHODS OF LED MODULE

Pls Note: This series is able to work in either Constant Current mode (a direct drive way) or Constant Voltage mode (usually through additional DC/DC driver) to drive the LEDs

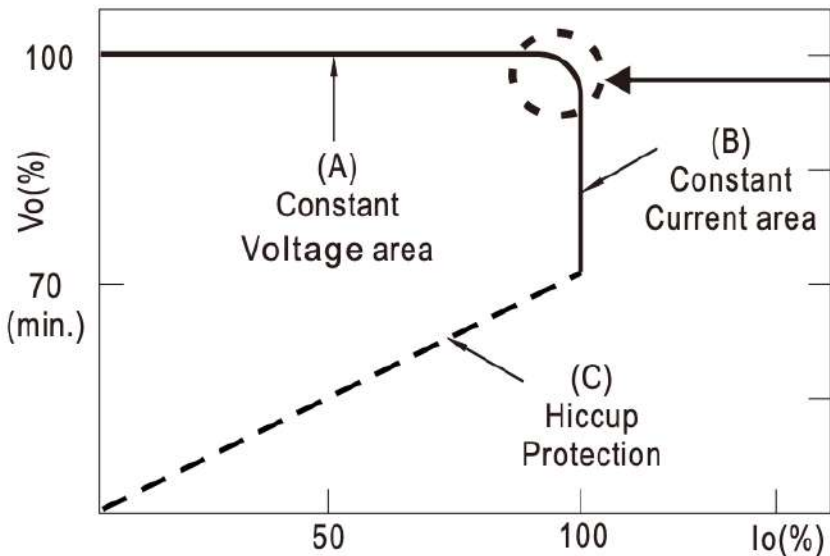

In the constant current region, the highest voltage at the output of the driver depends on the configuration of the end systems.

Should there be any compatibility issues, please please contact us.

8. Characteristics & Derating

OUTPUT LOAD vs TEMPERATURE

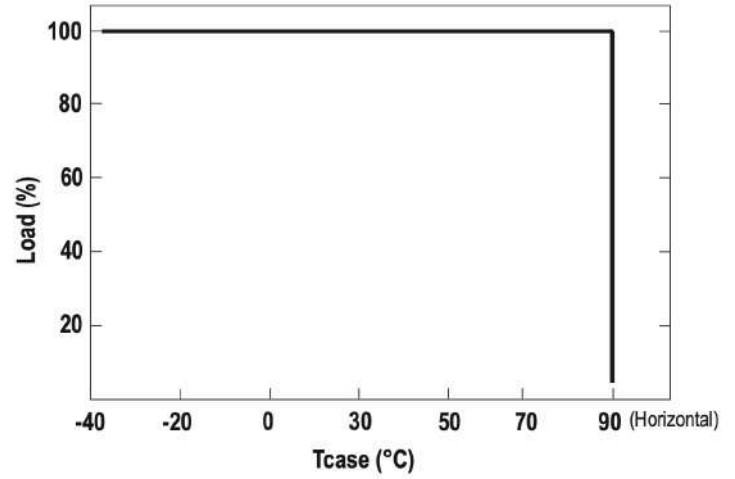
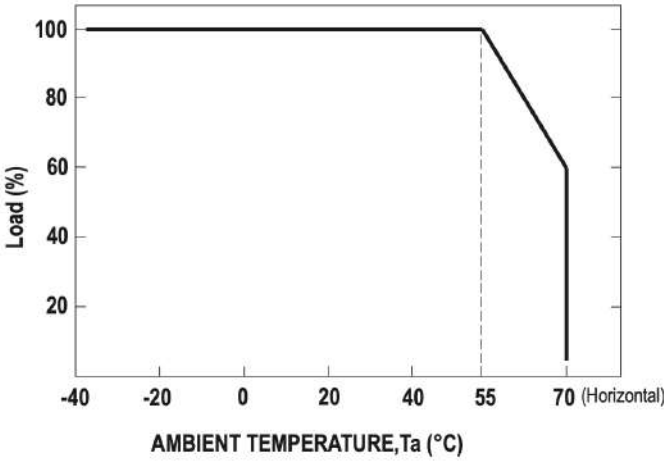

STATIC CHARACTERISTIC

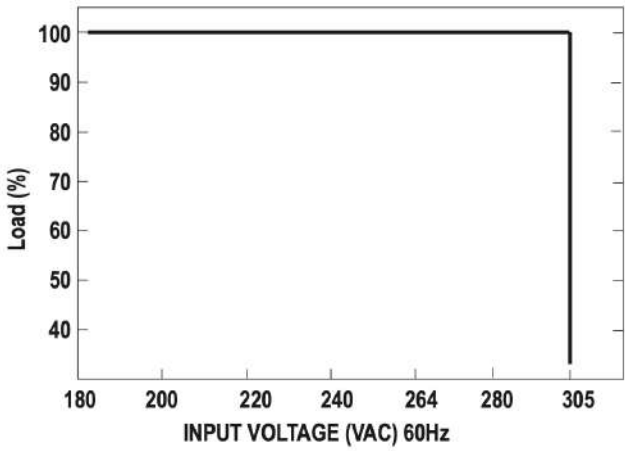

LIFE TIME

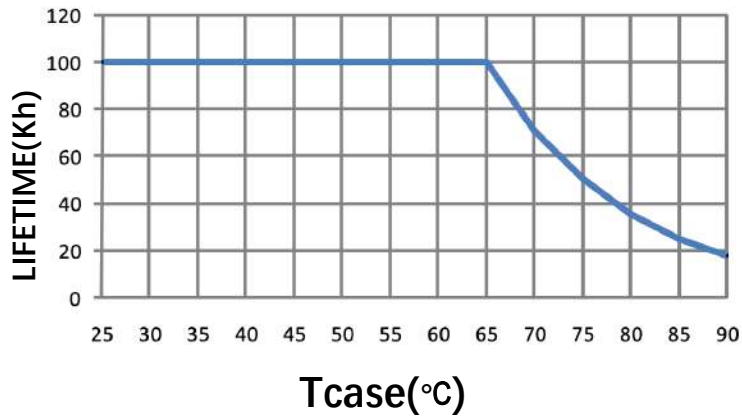

9. Mechanical Mounting

DIMENSION	155(L)*55 (W)*35(H) mm		
Input Cable	AC/N(Blue) AC/L(Brown) FG(Green/Yellow)	VDE 17AWGx3C & 3x1.0mm ²	200±20mm Length
Output Cable	V+(RED)/Brown, V-(BLACK)/Blue	VDE 17AWGx2C & 2x1.5mm ²	200±20mm Length

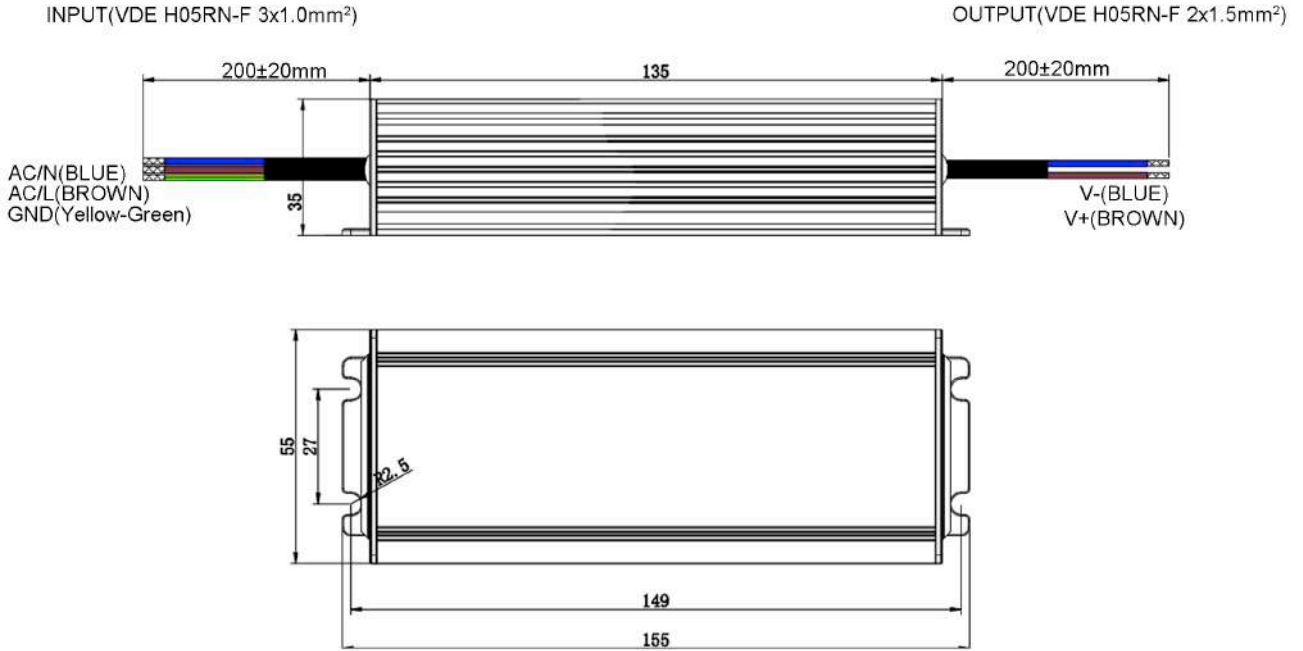

10. Product Label

<ul style="list-style-type: none"> ● AC/N(BLUE) ● AC/L(BROWN) ⊕ GND (GREEN/YELLOW) 	PRI	APMS-100-12	Suitable for dry/damp /wet locations CONSTANT VOLTAGE LED DRIVER	SEC	Vo- (BLUE) ● Vo+ (BROWN) ●
		PRI: 100-240V~50/60Hz, 1.5A max, $\lambda > 0.95$ SEC: +12V === 8.0A RATED POWER: 96W Max ta:50°C, tc:90°C	SELV IP67		

Silvery color

10. Installation Manuel & Caution

- (1). Before commencing any installation or maintenance work, please disconnect the power supply from the utility. Ensure that it cannot be re-connected inadvertently.
- (2). Keep proper ventilation around the unit and do not put any object on it. 15-20cm clearance must be kept when the adjacent device is a heat source
- (3). Operating under high ambient temperature may cause the internal component temperature and will require a de-rating in output load
- (4). Install in wet condition need use waterproof connectors, make sure there is no space between the unit and lighting fixtures.
- (5). Output current and output wattage must not exceed the rated values on the specifications
- (6). Wiring
 - Connect the ACL wire (Brown) of the LED power supply to Live (black or brown).
 - Connect the ACN wire (Blue) of the LED power supply to Neutral (white or blue)
- (7) . Risk of electrical shock and energy hazard. All failure should be examined by a qualified technician. Please do not remove the case of the power supply by yourself!
- (8). Can' t be installed under water or buried in soil directly
- (9). Please do not install LED power supplies in places with high ambient temperature or close to fire source
- (10). The FG (⊕) must be well connected to PE(protective earth)
- (11). If the external flexible cable or cord of this switching power supply is damaged, it shall be exclusively replaced by the manufacturer or similar qualified person in order to avoid a hazard.